



FORD PERFORMANCE
PARTS

CATALOG

To view products, simply click on the product verbiage and you will be taken to the desired page.

BRONCO ACCESSORIES	3	EXPLORER ACCESSORIES	75
BRONCO APPEARANCE	4	EXPLORER APPEARANCE	76
BRONCO INTERIOR	17	EXPLORER PERFORMANCE	77
BRONCO PERFORMANCE	18	MAVERICK ACCESSORIES	78
BRONCO SUSPENSION	19	MAVERICK APPEARANCE	79
BRONCO EXHAUST	20	CRATE ENGINES	80
BRONCO SPORT ACCESSORIES	22	CRATE ENGINE MODULAR COYOTE	81
BRONCO SPORT APPEARANCE	23	CRATE ENGINE PUSHROD 302	83
BRONCO SPORT EXHAUST	27	CRATE ENGINE PUSHROD 351	86
F-150 ACCESSORIES	28	CRATE ENGINE PUSHROD RACE	88
F-150 APPEARANCE	29	CRATE ENGINE ECOBOOST	90
F-150 PERFORMANCE	36	CRATE ENGINE PUSHROD 7.3L	91
F-150 SUSPENSION	37	CRATE ENGINES	92
F-150 EXHAUST	38	BRONCO PART NUMBERS	93
F-150 INTERIOR	39	F-150 PART NUMBERS	95
SUPER DUTY ACCESSORIES	40	SUPER DUTY PART NUMBERS	97
SUPER DUTY APPEARANCE	41	MUSTANG PART NUMBERS	98
SUPER DUTY EXHAUST	47	RANGER PART NUMBERS	100
SUPER DUTY PERFORMANCE	49	EXPLORER PART NUMBERS	101
MUSTANG ACCESSORIES	50	BRONCO SPORT PART NUMBERS	102
MUSTANG APPEARANCE	51	MAVERICK PART NUMBERS	103
MUSTANG PERFORMANCE	57	CRATE ENGINE PART NUMBERS	104
MUSTANG SUSPENSION	59		
MUSTANG EXHAUST	62		
MUSTANG INTERIOR	63		
RANGER ACCESSORIES	65		
RANGER APPEARANCE	66		
RANGER PERFORMANCE	72		
RANGER SUSPENSION	74		



**FORD PERFORMANCE
PARTS**

BRONCO ACCESSORIES



[PERFORMANCEPARTS.FORD.COM](https://www.performanceparts.ford.com)

SEPTEMBER 2023

**SUBURBAN
ACCESSORIES**



METHOD WHEEL KIT

Set of 5 Method Race Wheels® 703 Bead Grip®

- Matte Black Finish
- Bead Grip® technology engages tire bead for increased grip at low tire pressures
- 5 TPMS Sensors and Activation Tool
- 17" x 8.5" wide

Part Number: M-1007K-M1785MB

EVERGLADES WHEEL KIT

Set of 5 Carbonized Gray wheels

- As found on Everglades Edition
- 5 TPMS Sensors and Activation Tool
- 5 Bronco Center Caps
- *Tire not included*
- 17" x 8.5" wide with 30mm Offset

Part Number: M-1007K-P1785E

BLACK LUG NUTS

- Fits M12 x 1.5 wheel stud
- Vehicle kit contains 24 lug nuts
- Black chrome finish.

Part Number: M-1012K-BR





MATTE BLACK WITH MACHINED FACE KIT

Set of 5 Matte Black Wheels

- Fits 2021-2023 Broncos
- Not found on any production program.
- Includes 5 TPMS sensors, activation tool, and center caps.
- Tires: 285/70R17 BFGoodrich K02 Tires.

17X8.5 WIDE WITH 30MM OFFSET

Part Number: M-1007K-P1785MBM

17X8.0 WIDE WITH 55MM OFFSET

Part Number: M-1007K-P1780MBM

SINISTER BRONZE WITH MACHINED FACE KIT

Set of 5 Sinister Bronze Wheels

- Fits 2021-2023 Broncos
- Not found on any production program.
- Includes 5 TPMS sensors, activation tool, and center caps.
- Tires: 285/70R17 BFGoodrich K02 Tires.

17X8.5 WIDE WITH 30MM OFFSET

Part Number: M-1007K-P1785BRN

17X8.0 WIDE WITH 55MM OFFSET

Part Number: M-1007K-P1780BRN





2021+ BRONCO BEAD LOCK CAPABLE WHEEL KIT - WILDTRAK

Set of 5 Gloss Black bead lock capable wheels.

- Standard trim ring with Gloss Black finish, as found on Wildtrak and First Edition Models
- 5 TPMS Sensors and Activation Tool
- 5 Bronco Center Caps
- 17" x 8.5" wide
- 30mm Offset
- Suitable for Overlanding
- NOTE: Tires not included. Not compatible with Bronco Raptor

Part Number: M-1007K-DC1785A

2021-2023 BRONCO 17"X8" BEAD LOCK CAPABLE WHEEL KIT - BADLANDS

Set of 5 Gloss Black bead lock capable wheels

- Standard trim ring with Carbonized Gray finish, as found as optional on Badlands series Bronco
- 5 TPMS Sensors and Activation Tool
- 5 Bronco Center Caps
- 17" x 8.0" wide
- 55mm Offset
- Suitable for Overlanding
- NOTE: Tires not included. Not compatible with Bronco Raptor.

Part Number: M-1007K-DC178B





2021-2023 BRONCO 18" X 8" BLACK MACHINED FACE WHEEL KIT

Kit includes:

- Set of 5 Wheels - 18" x 8"
- Bucking Bronco Center Cap
- TPMS sensor and activation tool kit
- Note: not compatible with Bronco Raptor

Part Number: M-1007K-BB5



2021-2023 BRONCO 17" X 8.5" WHEEL KIT - DYNO GRAY

Kit Includes:

- 5 TPMS Sensors and Activation Tool
- 5 "FORD" Raptor style Center Caps
- 6-lug, 139.7mm bolt circle

Wheel & Tire Kit Adds:

- 33"285/70R/17 BF Goodrich All Terrain T/A KO2 Tires

NOTE: not compatible with Bronco Raptor

Part Number: M-1007K-BR1785





2021+ BRONCO BLACKOUT KIT - SASQUATCH

Blackout Package Includes:

- Five Gloss Black Trim Rings
- Rear Emblem- Gloss Black
- Black Lug Nut Vehicle Kit
- Black Stainless Steel License Plate Frame

Part Number: M-1019-BBK

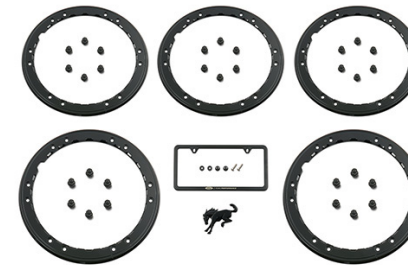

M14X1.5 BLACK SECURITY LUG NUT KIT OF 5

- Fits 2023+ Ford Bronco Raptor
- Fits M14 x 1.5 wheel stud
- Black chrome finish
- Kit contains 5 security lug nuts and key

Part Number: M-1A043-A5



M12X1.5 BLACK SECURITY LUG NUT KIT OF 5

- Fits 2021-2023 Ford Bronco
- Fits M12 x 1.5 wheel stud
- Black chrome finish
- Kit contains 5 security lug nuts and key

Part Number: M-1A043-B5





BEAD LOCK TRIM RING KIT

- Fits 2021-2023 Bronco with Factory Bead lock capable wheels
- Fits all Sasquatch Package (675) equipped vehicles
- Fits optional Bead lock Capable wheel (64W) found on Badlands trim
- Includes 5 trim rings
- Provide an easy way to customize your Bronco adding a unique look
- Available in Orange, Red, and Black

ORANGE BEAD LOCK TRIM RING KIT

Part Number: M-1021K-BLO

RED BEAD LOCK TRIM RING KIT

Part Number: M-1021K-BLR

BLACK BEAD LOCK TRIM RING KIT

Part Number: M-1021K-BLB





TUBE DOOR KIT

- High-strength, 2" steel Tube Door Kit from Ford Performance
- Helps provide added brush protection
- Available in 2 Door and 4 Door Bronco models including Bronco Raptor

2-DOOR

Part Number: M-19008-BTD2

4-DOOR

Part Number: M-19008-BTD4



HOOP STEPS

- Textured Matte Black Finish Fits: 2021-2023 Bronco 4-Door
- Hoop Steps can be removed from the rail for added ground clearance
- Rail cannot support the weight of the vehicle
- Bolt-On Installation
- Installation hardware included
- Sold as a pair (left & right sides)

Part Number: M-16450-BH4





RIGID® ROOF MOUNTED & POD LIGHTS

- Ford Performance worked with one of the most recognized names in Off-Road lighting
- Perfect for Overlanding
- For hard/soft top equipped Bronco

RIGID MIRROR MOUNTED LIGHTS

Part Number: M-15200K-BML

RIGID 40" OFF-ROAD LIGHT BAR

Part Number: M-15200K-BRRL





BRONCO DUAL MOUNTED MIRROR OFF-ROAD LIGHTS

- This kit features the RIGID® 360-Series 4 Inch LED Off-Road Lights.
- 8,600 Raw Lumens
- 3,060 Lumens
- 28 Watts
- 50,000 Hr LED Lifespan
- Light Pattern - Drive
- Sold as a set of 4 lights
- Universal harness and universal switch are not included.

Part Number: M-15200K-BDML



RIGID® OFF-ROAD UNDER BODY/ ROCK LIGHT KIT

- Perfect for overlanding
- This kit contains 4 RIGID® LED Rock Lights plus 15-foot leads to each light, power distribution block, switch, and light mounts
- RIGID® Rock Lights contain a high quality black aluminum housing with a durable polycarbonate lens.
- Available in white and amber

WHITE

Part Number: M-15200-RUN

AMBER

Part Number: M-15200-RUNA





WINCH KIT

- Unique WARN 10,000 lb. Winch
- 100-foot spydura synthetic winch line
- 10,000 lb. winch hook
- Red hook strap
- Wired remote control
- Required bracketry and hardware
- Front License Plate Bracket

Part Number: M-1821-B



WINCH RECEIVER KIT

- Allows you to operate your Bronco or Super Duty winch using the Bluetooth connection on your smart device.

Part Number: M-1821-WR





BRONCO UNDERHOOD AIR COMPRESSOR KIT

- The under-hood mounting kit includes the ARB twin compressor, switch, and manifold and bracket
- Powder Coated Black
- Convenient switch location next to compressor
- Bolt-on solution installs easily

Part Number: M-1830-BRC

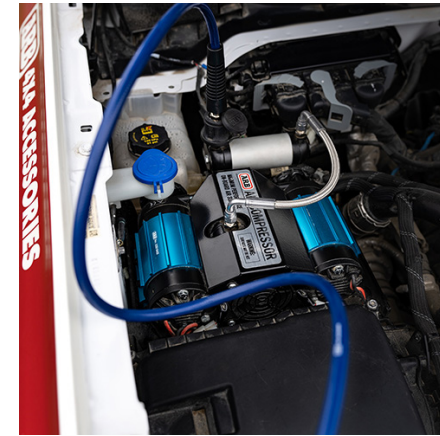

2021-2023 BRONCO HOOD LIFT KIT

- Designed to lift the hood approximately 8 inches above the prop rod height for easier engine bay access
- Black e-coated progressive-rate gas struts provide a smooth hood opening with a reduced rate as it reaches its final position
- No drilling required
- Note: not compatible with Everglades or Bronco Raptor

Part Number: M-16826-B





BRONCO/BRONCO SPORT G.O.A.T. BADGE - BLACK/BLACK

- Black on black chrome G.O.A.T. badge
- 4.5" Long x 1.36" Wide
- Can be attached on tailgates, fenders, doors, engine covers, etc.

Part Number: M-1447-GOATBLK



BRONCO REAR EMBLEM - GLOSS BLACK

- Gloss Black Rear Bronco Emblem
- Original equipment on 2021 Bronco Wildtrak Series.

Part Number: M-1447-BRB

2021+ BRONCO GRILLE LETTERING OVERLAY KIT - MATTE BLACK

- Aligns perfectly to apply over existing production grille letters
- Kit includes:
- Individual B-R-O-N-C-O grille letter emblem overlays.
 - No drilling required

Part Number: M-1447-BLMB





TOW HOOKS

- Titanium double shear pin
- Max Rated Load: 16,000 lbs
- Ford Performance by Factor 55 Ultrahook includes the hook and exclusive Ford Performance rope guard.

RED

Part Number: M-1821-UHR

BLUE

Part Number: M-1821-UHB





2021+ BRONCO FORD PERFORMANCE SILL PLATE KIT

- Fits 2021+ Bronco 4-Door only
- Original equipment on Bronco Raptor
- Brushed metal Ford Performance logo
- Durable black ABS construction
- Easy installation
- Set includes both the right and left sill plate

Part Number: M-1613208-B



2021-2023 BRONCO CARBON FIBER GRAB HANDLE KIT

Upgrade the look of your interior with Carbon Fiber accent pieces.

Kit includes:

- LH Grab Handle
- RH Grab Handle
- Center Console
- Low-Gloss finish
- Easy installation

Part Number: M-7220-BCF





BRONCO PRO CALIBRATION KITS

- Delivers improved throttle response throughout RPM range
- Can change tire size up to BFG 37x12.5R17 KO2 size
- Available for the 2.3L and 2.7L

2.3L

- Peak torque = 385 lb.-ft. at 3,500 RPM
- Peak power = 330 HP at 5,500 RPM

Part Number: M-9603-B23

2.7L

- Peak torque = 433 lb.-ft. at 3,500 RPM
- Peak power = 355 HP at 5,500 RPM

Part Number: M-9603-B27

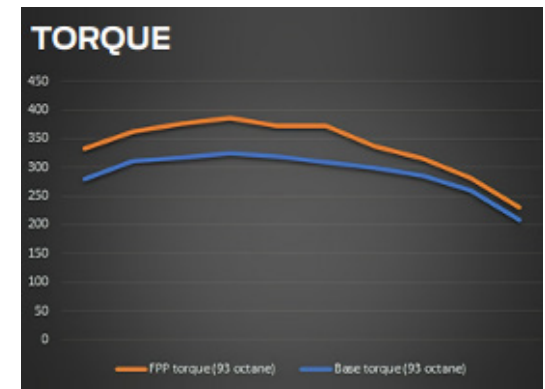
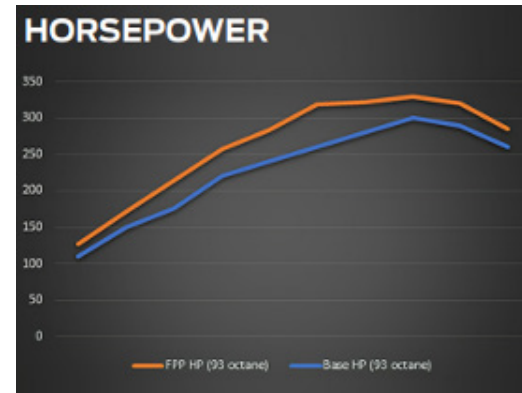



OFF-ROAD SUSPENSION 2" LIFT KIT

- Available for the 2-Door & 4 Door Bronco
- Approximately 2" of lift results in optimal ground clearance and approach/departure angles
- Kit includes bolt-in front and rear coil-over packages, utilizes both Bilstein and Ford OE components
- Designed and optimized as an upgrade to Base, Big Bend, Black Diamond, and Outer Banks Series
- Not validated against Sasquatch Package, Badlands, Everglades, and Raptor

2 DOOR KIT

Part Number: M-18000-B1A

4 DOOR KIT

Part Number: M-18000-B1





CAT BACK EXHAUST

- Available for the 2021 - 2023 Bronco 2.3L & 2.7L
- Uniquely designed and tuned to provide optimum performance, aggressive sound, durability and pure driving excitement
- 50-State legal - Meets 95 decibel drive-by noise standard for aftermarket exhaust systems when installed on stock applications
- 3.5" Black Chrome-Plated Stainless Steel Tips or 3.5" Chrome-Plated Stainless Steel Tips

2.3L BLACK TIP-PLATED STAINLESS-STEEL

Part Number: M-5230-BR3SB

2.7L BLACK TIP-PLATED STAINLESS-STEEL

Part Number: M-5230-BR7SB

2.3L CHROME TIP-PLATED STAINLESS-STEEL

Part Number: M-5230-BR3SC

2.7L CHROME TIP-PLATED STAINLESS-STEEL

Part Number: M-5230-BR7SC



SCAN THE QR TO
HEAR THE 2.7L
EXHAUST IN ACTION.





2021-2023 BRONCO HIGH CLEARANCE EXHAUST SYSTEM

- Uniquely designed and tuned to provide optimum performance, aggressive sound, durability and pure driving excitement
- Features 2.75" inlet & high clearance, slash-cut tailpipes with ultra-smooth mandrel bends and superior craftsmanship

2.3L

Part Number: M-5230-BR3

2.7L

Part Number: M-5230-BR7

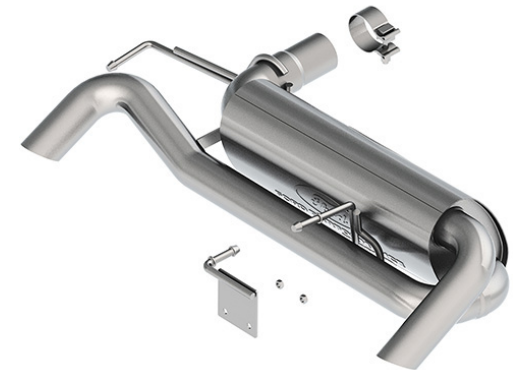
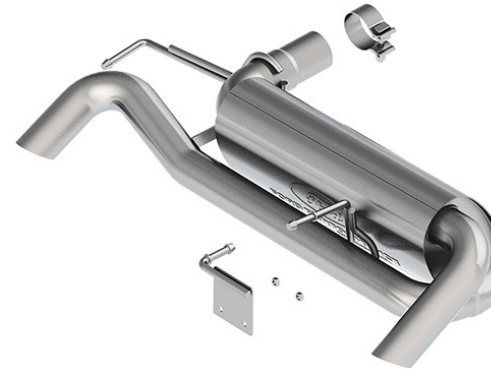



**FORD PERFORMANCE
PARTS**

BRONCO SPORT ACCESSORIES



[PERFORMANCEPARTS.FORD.COM](https://www.performanceparts.ford.com)

SEPTEMBER 2023

**SUBURBAN
ACCESSORIES**



RIGID® OFF-ROAD UNDER BODY/ROCK LIGHT KIT

- Perfect for overlanding
- This kit contains 4 RIGID® LED Rock Lights plus 15-foot leads to each light, power distribution block, switch, and light mounts
- RIGID® Rock Lights contain a high quality black aluminum housing with a durable polycarbonate lens.

WHITE

Part Number: M-15200-RUN

AMBER

Part Number: M-15200-RUNA



FORD PERFORMANCE PARTS BY RIGID® BRONCO SPORT ROOF OFF-ROAD LIGHT BAR KIT

- Fits 2021-2023 Bronco Sport Badlands or First Edition with the 2.0L EcoBoost engine.
- This kit allows for the installation of a 40" off-road light bar onto the Bronco Sport's roof and contains: RIGID® Radiance Plus SR-Series 40" light bar, unique harness, brackets, switch, and lens covers.

Part Number: M-15200K-CXR





2021-2023 BRONCO SPORT 17" X 7" WHEEL KIT -GLOSS BLACK

- Fits 2021 - 2023 Bronco Sport
- 17" x 7" Gloss Black Finish
- OEM Quality - as originally offered on Bronco Sport First Edition
- Kit Includes:
 - Set of 4 wheels 17" x 7"
 - TPMS sensor and activation tool kit M-1180-B
 - 4 Bronco center caps
 - Offset 37.5" mm

Part Number: M-1007K-BS17GB



2021+ BRONCO SPORT 17" WHEEL KIT -LOW GLOSS BLACK

- Fits 2021 - 2023 Bronco Sport
- 17" x 7" Low-Gloss Black Finish
- Kit Includes:
 - Set of 4 wheels 17" x 7"
 - TPMS sensor and activation tool kit M-1180-B
 - 4 Bronco center caps
 - Offset 37.5" mm

Part Number: M-1007K-S17BSB





BRONCO/BRONCO SPORT G.O.A.T. BADGE

- Fits 2021-2023 Ford Bronco Sport
- Black chrome finish
- Fits M14 x 1.5 wheel stud
- Kit contains 20 Lug Nuts

Part Number: M-1012K-BSB

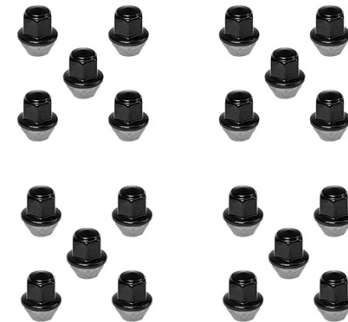

M12X1.5 BLACK SECURITY LUG NUT KIT OF 4

- The perfect security solution for use with M-1012K-BSB vehicle black lug nut kits
- Fits M14 x 1.5 wheel stud
- Black chrome finish
- Kit contains 5 security lug nuts and key

Part Number: M-1A043-B





**FORD PERFORMANCE
PARTS**

BRONCO SPORT APPEARANCE

M12 X 1.5 BLACK LUG NUT VEHICLE KIT OF 20

- Available in black-on-chrome or black-on-black
- 4.5" Long x 1.36" Wide
- Can be attached on tailgates, fenders, doors, engine covers, etc.
- Silk-screened vacuum-formed ABS with UV resistant coating
- Automotive-grade double sided tape included on back of badge

BLACK

Part Number: M-1447-GOATBLK

CHROME

Part Number: M-1447-GOAT





2021-2023 BRONCO SPORT 2.0L SPORT EXHAUST

- Fits 2021 - 2023 Bronco Sport 2.0L
- Uniquely designed and tuned to provide optimum performance, aggressive sound, durability and pure driving excitement
- 50-State legal - Meets 95 decibel drive-by noise standard for aftermarket exhaust systems when installed on stock applications
- Made from high-quality 304 stainless steel
- Features ultra-smooth mandrel bends and superior craftsmanship
- Available in chrome and black chrome

BLACK

Part Number: M-5230-BSB

CHROME

Part Number: M-5230-BSC





**FORD PERFORMANCE
PARTS**

F-150 ACCESSORIES



[PERFORMANCEPARTS.FORD.COM](https://www.performanceparts.ford.com)

SEPTEMBER 2023

**SUBURBAN
ACCESSORIES**



OFF-ROAD BLACK PACKAGE

- Includes black front grille, front red tow hooks, black fender vents, Ford Performance bedside decal, black tailgate lettering, black exhaust tips, Ford Performance off-road suspension leveling kit, 20-inch gloss black wheels, and black lug nuts.
- Available with Smoked Ford Oval Kit for Vehicles with Front Camera (Part # M-1447-FBC1) and Smoked Ford Oval Kit for Vehicles without Front Camera (M-1447-F15B)

Part Number: M-F150-OR20



20"x8.5" GLOSS BLACK WHEELS

UNIQUE FORD PERFORMANCE
BEDSIDE DECAL

BLACK-PAINTED
TAILGATE LETTERING

FORD PERFORMANCE TONNEAU COVER 5.5FT BED

- Fits 2015-2023 F-150 equipped with 5.5" Bed
- Tri-fold design
- Double-pivot hinges, steel corner brackets, and I-beam bows to provide an extremely strong frame
- Premium Vinyl with large "Ford Performance" embossment

Part Number: M-98150-FP





M14X1.5 BLACK SECURITY LUG NUT KIT OF 4

- These are the perfect security solution for use with M-1012K-F15B vehicle black lug nut kits.
- Fits M14 x 1.5 wheel stud
- Kit contains 4 security lug nuts and key

Part Number: M-1A043-A



BLACK LUG NUTS

- Fits M14 x 1.5 wheel stud
- Vehicle Kit contains 24 Lug Nuts
- Black chrome finish

Part Number: M-1012K-F15B





2021+ F-150 18" MATTE BLACK WHEEL KIT

- Fits 2015-2023 F-150
- Matte Black finish
- +34mm Offset
- Set of 4 -18" x 7.5" Wheels
- Includes 4 black chrome Ford oval center caps
- Includes M-1180-B TPMS sensor and activation tool kit

Part Number: M-1007K-1875MB



20" & 22" WHEEL & TIRE KIT

- Clear-coated gloss black paint with eye-catching Ford Performance-branded spokes
- 20" Mounted and Balanced Kit w/ 275/60R20 Goodyear Wrangler Duratrac Tires
- 22" Mounted and Balanced Kit w/ 285/45R22 Bridgestone Dueler H/ L Alenza Tires
- Take Off Credit for 18" is \$500
- Take Off Credit for 20" & 22" is \$800

20" WHEEL & TIRE PACKAGE (MOUNTED/BALANCED)

Part Number: M-1007K-S2085F15B

22" WHEEL & TIRE PACKAGE (MOUNTED/BALANCED)

Part Number: M-1007K-S2295GB





BLACK WITH MACHINED FACE

- Tires: 285/45R22 Bridgestone Dueler H/L Alenza Tires
- Gloss black paint finish, with bordering silver machined face
- Set of 4 - 22" x 9.5" Wheels
- 44mm offset
- Includes 4 black chrome Ford oval center caps

Part Number: M-1007K-S2295B



SINISTER BRONZE

- Tires: 285/45R22 Bridgestone Dueler H/L Alenza Tires
- All-New Sinister Bronze finish, with "Ford Performance" logo, clear-coated to OEM standards
- Set of 4 - 22" x 9.5" Wheels
- 44mm offset
- Includes 4 black chrome Ford oval center caps

Part Number: M-1007K-S2295SB





2021-2023 F-150 BLACK OVAL KIT

- Set of front and rear smoked chrome ovals.

Part Number: M-1447-FBC1/M-1447-F15B

FORD PERFORMANCE F-SERIES WINDSHIELD BANNER

- Fits 2021-2023 F-150
- Die-cut lettering that will adhere to a properly prepared windshield
- Designed specifically to follow the natural curvature of the factory windshield
- Banner has white "FORD" and red "PERFORMANCE" lettering

Part Number: M-1820-WR

9.75" F-150 RAPTOR DIFFERENTIAL COVER

- Ford Performance branded differential cover
- Fits all F-150 and Raptor with 9.75" differential
- Rugged "hammered" powdercoat finish
- Features magnetic drain plug

Part Number: M-4033-F975





2015-2023 F-SERIES OFF-ROAD RUNNING BOARD

- Textured Matte Black Finish
- Fits 2015-2023 F-150 Crew Cab
- Bolt-on installation
- Installation hardware included
- Sold as a pair

Part Number: M-16450-FSORB



2015-2023 F-150/RAPTOR CHASE RACK

- Fits 2015-2023 F-150 and 2017-2023 F-150 Raptor
- Accommodates 50" RIGID® LED Light Bar (or similar)
- Can be used with or without installation of included light bar brackets
- Features "Ford Performance" on the side panels
- Retains factory high-mount stop light
- Durable, three-stage black powder-coated finish
- Bolt-on installation
- Includes black oxide stainless steel hardware

Part Number: M-19007-F15R





2015-2023 F-150 TOW HOOKS

- Fits all 2015-2023 F150 trucks
- Works on 4x4 or 4x2 trucks
- Durable, unique red powder coated finish
- Sold in pairs

RED

Part Number: M-18954-F15R

BLUE

Part Number: M-18954-F15B

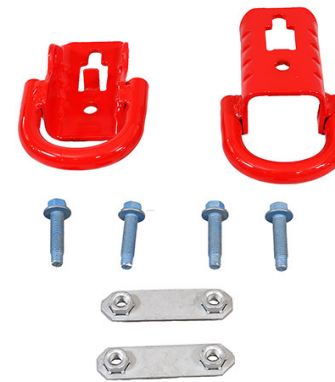



3.0L WHIPPLE SUPERCHARGER KIT

- Produces 700 hp at 6,500 RPM and 590 lb/ft of torque at 5,000 RPM.
- Features the Gen 5x 3.0L Whipple Supercharger
- Whipple exclusive inverted twin-screw design
- Patented dual pass intercooler
- Ford Performance exclusive calibration
- Tomahawk calibration tool included

SUPERCHARGER KIT

Part Number: M-6066-F150SCA

SUPERCHARGER KIT WITH PRO POWER ON BOARD

Part Number: M-6066-F150SCB



2021+ F-150 FRONT SKID PLATE KIT

- Fits all 2022+ F-150 4X4 equipped vehicles
- Factory equipment on F-150 Tremor Package
- Replaces factory front air dam with durable, steel front bash plate finished in Silver

Part Number: M-5018-FSP





OFF-ROAD SUSPENSION 2" LEVELING KIT

- Fits: 2021-2023 F-150 4X4 Models
- Not recommended for 4x2 drivetrain, F-150 Tremor, 3.5L PowerBoost Hybrid, 3.0L Diesel, and Heavy-Duty Payload Package (627)
- Does not fit vehicles with Dynamic Suspension.
- Does not fit F-150 Raptor & F-150 Lightning
- Direct bolt in replacement suspension package, improving both ride quality and stance of vehicle
- Levels truck 2" Front-Rear, with 2.5" front groove available for additional height
- Full 60mm digressive piston in a massive 2.65" mono-tube Ford Performance tuned coilover package
- Remote rear reservoirs house independent dividing pistons to separate nitrogen chambers, optimizing suspension travel

Part Number: M-18000-F15B



2021+ F-150 REAR LOWERING KIT

- Fits 2021+ F-150 2WD and 4WD Regular Cab, SuperCab, and SuperCrew
- Reduces rear ride height approximately 1.5", giving you more of the leveled, sport truck stance you want
- Kit includes laser-cut steel lowering shackles with urethane bushings

Part Number: M-3000-HB





EXHAUST REAR EXIT

- Fits 2021-2023 F-150 2.7L & 3.5L EcoBoost® and 5.0L with 145" & 157" wheelbase. 157" wheelbase trucks require mid-pipe extension (Part #M-5248-FEXT)
- Extreme is our most aggressive exhaust sound yet!
- Manufactured in the USA from high quality 304 stainless steel
- Features ultra-smooth mandrel bends, warp-free flanges and superior craftsmanship
- Dual rear exit with black chrome plated 4-inch stainless steel exhaust tips
- Available in Black and Chrome Tips
- Available in Touring, Sport, and Extreme Sound Levels

Part Number: M-5200-FEBR

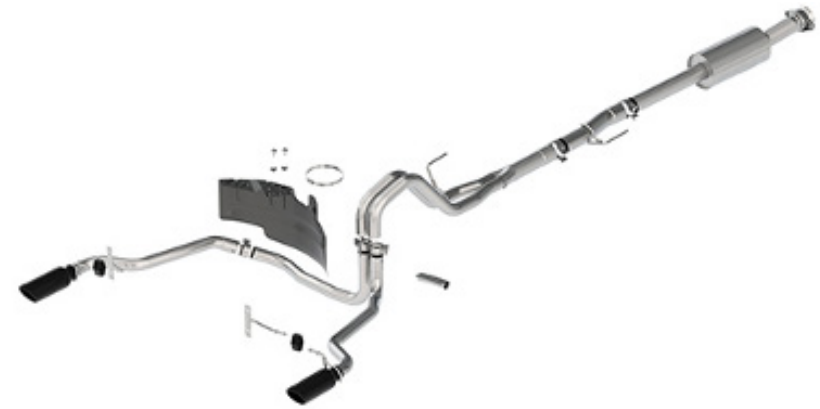

*Extreme Exhaust Rear Exit with Black Tips shown.

EXHAUST SIDE EXIT

- Extreme is our most aggressive exhaust sound yet!
- Manufactured in the USA from high quality 304 stainless steel
- Features ultra-smooth mandrel bends, warp-free flanges and superior craftsmanship
- Available in Black and Chrome Tips
- Available in Touring, Sport, and Extreme

Part Number: M-5200-FEBS



*Extreme Exhaust Side Exit with Black Tips shown.



2015-2022 FORD PERFORMANCE PREMIUM F-150 FRONT FLOOR MAT SET

- Fits 2015-2022 F-150
- Premium-grade black carpeting is custom fit to the exact contour of F-150
- "Ford Performance" logo patch is sewn to the floor mat for long lasting durability
- Mat retention on driver-side only

Part Number: M-13086-FA



2015-2023 F-150 FORD PERFORMANCE SILL PLATE SET

- Fits all 2015-2023 F-150 SuperCrew
- Original equipment on F-150 Raptor SuperCrew
- Brushed metal Ford Performance logo
- Durable black ABS construction
- Easy installation
- Set includes both the right and left sill plate

Part Number: M-1613208-F15A





**FORD PERFORMANCE
PARTS**

SUPER DUTY ACCESSORIES



[PERFORMANCEPARTS.FORD.COM](https://www.performanceparts.ford.com)

SEPTEMBER 2023

**SUBURBAN
ACCESSORIES**



WINCH KIT

- The Ford Performance by WARN® Super Duty Winch Kit was co-developed by Ford and WARN engineers to develop a winch solution for the 2020-2022 Super Duty that offers an OEM level of fit, finish, durability, and vehicle integration. The Ford Performance by WARN Super Duty Winch Kit includes:
- Unique WARN® 12,000 lb. Winch
- 70-foot synthetic winch line
- 12,000 lb. Epic winch hook
- “Ford Performance” branded blue hook strap
- Wireless and wired remote controls
- Required bracketry and hardware



Part Number: M-1821-SD

WINCH KIT RECEIVER

- Allows you to operate your Bronco or Super Duty winch using the Bluetooth connection on your smart device.

Part Number: M-1821-WR





TOW HOOK

- Titanium double shear pin
- Max Rated Load: 16,000 lbs
- Ford Performance by Factor 55 Ultrahook includes the hook and exclusive Ford Performance rope guard.

BLUE

Part Number: M-1821-UHB

RED

Part Number: M-1821-UHR



2017-2023 SUPER DUTY TOW HOOKS

- Fits all 2017-2023 Super Duty trucks
- Works on 4x4 or 4x2 trucks
- Durable, unique powder coated finish
- Sold in pairs

BLUE

Part Number: M-18954-SDB

RED

Part Number: M-18954-SDR





2005-2023 SUPER DUTY 20" CALIBER WHEEL KIT -GLOSS BLACK

- Fits 2005 - 2022 Super Duty F-250 and F-350 Single Rear Wheel Models
- 20" x 8" Painted High Gloss Black Premium Aluminum Wheels
- OEM Quality - as originally offered on the 2022 F-250 & F-350 Super Duty Black Appearance Package
- Includes two open and two closed "FORD" center caps painted high gloss black to match the wheels on 4WD applications
- Includes four TPMS sensors and activation tool kit for use with 2017 - 2022 MY Super Duty applications

Part Number: M-1007K-S2008GB1



2005-2023 SUPER DUTY 20" X 8" PREMIUM BLACK PAINTED ALUMINUM WHEEL PACKAGE

- Fits 2005 - 2022 Super Duty F-250 and F-350 Single Rear Wheel Models
- 20" x 8" Painted High Gloss Black Premium Aluminum Wheels
- OEM Quality - as originally offered on the 2019 F-250 & F-350 Super Duty Lariat Sport Package
- Includes two open and two closed "FORD" center caps painted high gloss black to match the wheels on 4WD applications.
- Includes four TPMS sensors and activation tool kit for use with 2017 - 2022 MY Super Duty applications

Part Number: M-1007K-SU2008EB





MATTE BLACK WHEEL KIT

- Fits 2005 - 2023 Super Duty F-250 and F-350 Single Rear Wheel Models
- 18" x 8" Low-Gloss Matte Black Finish
- OEM Quality - as originally offered on Super Duty Tremor package
- Includes four TPMS sensors and activation tool kit for use with 2017 - 2023 Super Duty applications

Part Number: M-1007K-1808SD



OFF-ROAD RUNNING BOARDS

- F-Series Tremor Off-Road Running Boards - Textured Matte Black Finish
- Fits: 2015-2022 F-150 Crew Cab and 2017-2023 F-Super Duty Crew Cab
- Original Equipment on the Super Duty Tremor
- Bolt-on installation
- Sold as a pair (left and right sides)

Part Number: M-16450-FSORB





BLACK OVAL KIT

- Fits 2020-2022 Super Duty with or without camera provision
- For use on XL/XLT/Lariat Trims
- Kit includes front smoked chrome oval -with or without camera provision and Rear smoked chrome oval

WITHOUT CAMERA PROVISION BLACK OVAL KIT

Part Number: M-1447-SDC

WITH CAMERA PROVISION BLACK OVAL KIT

Part Number: M-1447-SDB



RIGID OFF-ROAD UNDER BODY LIGHT KIT

- These lights are mounted in the wheel well or other strategic locations to enable off-road vehicles to illuminate trails as well as difficult, rocky terrain. Perfect for Overlanding.
- This kit contains 4) RIGID® LED Rock Lights (White light) plus 15-foot leads to each light, power distribution block, switch, and light mounts. RIGID® Rock Lights contain a high-quality black aluminum housing with a durable polycarbonate lens.
- The same kit as M-15200-RUNA, but with white lights rather than Amber

Part Number: M-15200-RUN





**FORD PERFORMANCE
PARTS**

SUPER DUTY APPEARANCE

2017-2023 FORD PERFORMANCE SUPER DUTY CHASE RACK

- Fits 2017-2023 Super Duty Pickups
- Accommodates 50" RIGID® LED Light Bar (or similar)
- Can be used with or without installation of included light bar brackets
- Features "Ford Performance" on the side panels
- Retains factory high-mount stop light
- Durable, three-stage black powder-coated finish
- Bolt-on installation
- Includes black oxide stainless steel hardware

Part Number: M-19007-SD





2017-2023 SUPER DUTY EXHAUST TIP

- Fits 2017 - 2023 Super Duty 6.2L
- Fits 2020 - 2023 Super Duty 7.3L
- 4.5" double-wall stainless steel tip offers superior craftsmanship and provides a custom appearance with optimum durability
- Made from high-quality 304 stainless steel
- Available in Black Chrome and Chrome

BLACK CHROME

Part Number: M-5260-BCT3

CHROME

Part Number: M-5260-CT3





7.3L SPORT EXHAUST

- Fits 2020-2022 Super Duty 7.3L with 142", 148", 160", 164" & 175.5" wheelbases
- Ford Performance Sport exhaust systems are uniquely designed and tuned to provide an aggressive and throaty high-performance sound that is sure to enhance your driving experience
- Manufactured in the USA from high quality 304 stainless steel
- Features ultra-smooth mandrel bends, warp-free flanges and superior craftsmanship
- Dual side exit with black chrome plated 4.5" stainless steel exhaust tips
- Available in Chrome plated Tips

Part Number: M-5200-FSD73SB





**FORD PERFORMANCE
PARTS**

SUPER DUTY PERFORMANCE

FORD PERFORMANCE LOW PROFILE INTAKE FOR 7.3L GAS ENGINE

- 10hp over stock 2020 Super Duty manifold
- Utilizes the 92mm GT500 throttle body M-9926-M5292
- Designed for better hood clearance for 7.3L engine swaps
- Fits the M-6007-73 crate engine
- Custom engine calibration required

Part Number: M-9424-73LP





**FORD PERFORMANCE
PARTS**

MUSTANG ACCESSORIES



[PERFORMANCEPARTS.FORD.COM](https://www.performanceparts.ford.com)

SEPTEMBER 2023

**SUBURBAN
ACCESSORIES**



HP PERFORMANCE PACK WHEEL KIT

- Fits 2015-2023 Mustang
- Clears Performance Pack 6-piston brakes
- Matte Black paint finish, clear-coated to OEM standards
- Includes two 19" x 10.5" M-1007-DC19105MB front wheels and two 19" x 11" M-1007-DC1911MB rear wheels
- Includes Ford Performance Center Caps M-1096-FP3
- Includes M-1180-B TPMS sensor and activation tool kit

Part Number: M-1007K-DC19XMB



BLACK LUG NUTS

- Fits M14 x 1.5 wheel stud
- Kit contains 20 Lug Nuts
- Matte Black Finish

Part Number: M-1012K-MB





2015-2024 MUSTANG 5.0L FENDER EMBLEMS/BADGES PAIR

- Includes right and left side emblems/badges
- Two-way tape for easy installation
- Injection molded plastic
- Available in Black and Chrome finish

BLACK

Part Number: M-1447-M50AB

CHROME

Part Number: M-1447-M50A



FORD PERFORMANCE WHEEL CENTER CAP

- Ford Performance logo on a gloss black background

Part Number: M-1096-FP3





2018-2023 FORD PERFORMANCE MUSTANG CLEAR TAILLAMP KIT

- Fits all 2018-2023 Mustangs
- Kit includes both rear taillamps
- Quick, easy installation with factory plugs

Part Number: M-13504-MC



2015-23 MUSTANG REAR SPOILER WITH GURNEY FLAP

- Fits All 2015-2023 Mustang Coupes
- Aggressive rear spoiler with additional Gurney flap for added downforce
- Gloss Black OEM finish
- Kit includes:
 - Spoiler
 - Gurney flap
 - Mounting hardware
 - Installation template

Part Number: M-16600-FP





2005-2023 MUSTANG FORD PERFORMANCE WINDSHIELD BANNER-WHITE AND RED

- Fits 2005-2023 Mustang
- Die-cut lettering that will adhere to a properly prepared windshield
- Designed specifically to follow the natural curve of the factory windshield
- 48" long banner with 2" tall "FORD PERFORMANCE" script
- Banner includes white color "FORD" and red color "PERFORMANCE" lettering

Part Number: M-1820-MR



2015-2023 MUSTANG HOOD LIFT KIT W/ LASER ENGRAVED FORD PERFORMANCE LOGO

- Ford Performance Hood Lift Kit w/ Laser Engraved Ford Performance Logo
- 90 pounds rating
- Designed for use with all OEM base Mustang and Mustang GT hoods, as well as many aftermarket hoods
- These hood lifts utilize two gas struts that lift and hold the hood without the need for a prop-rod

Part Number: M-16826-MA





**FORD PERFORMANCE
PARTS**

MUSTANG APPEARANCE

M14X1.5 BLACK SECURITY LUG NUT KIT OF 4

- These are the perfect security solution for use with M-1012K-MB vehicle black lug nut kits.
- Fits M14 x 1.5 wheel stud
- Kit contains 4 security lug nuts and key

Part Number: M-1A043-A





2020-2022 GT500 CARBON FIBER

CARBON FIBER HOOD VENT

Part Number: M-16612-C20

CARBON FIBER FRONT SPLITTER

Part Number: M-16601-MCF

CARBON FIBER BUMPER INSERT

Part Number: M-17750-MCF

CARBON FIBER REAR DECKLID TRIM PANEL

Part Number: M-16600-MCF





ROUSH SUPERCHARGER KIT

- Fits 2022-2023 Mustang GT with manual or automatic transmission
- Produces 750 HP and 670 lb-ft of torque with 91 octane fuel
- Kit comes complete with all hardware for installation
- NOT compatible with the Mach 1
- 2.65L Twin Vortices (TVS) Supercharger Assembly
- Lower Intake manifold with integral air-to-liquid intercooler
- 87 mm electronic throttle body (M-9926-M50B)
- Air inlet system
- Fuel rails
- Complete air-to-liquid intercooler system includes pump, heat exchanger and reservoir
- Drive Belt: first sheave FEAD system
- 47 lb/hr, 6-hole, high-impedance fuel injectors



Part Number: M-6066-M8MY22

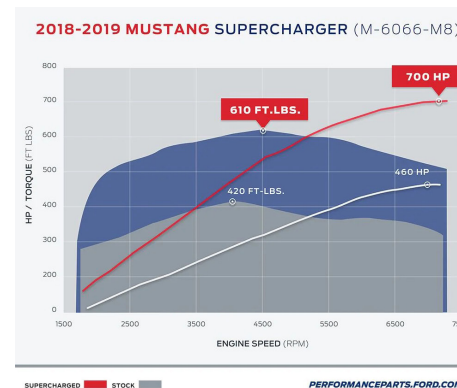



2015-2023 MUSTANG BULLITT™ BRAKE KIT

- Brembo 6-piston Gloss Red aluminum fixed front calipers
- Kit includes:
 - Bullitt(TM) Front Calipers
 - Bullitt(TM) Front Rotors
 - Bullitt(TM) Front Brake Pads
 - Bullitt(TM) Rear Calipers
 - Bullitt (TM)Rear Rotors
 - Bullitt(TM) Rear Brake Pads
 - Front Brake Hoses
 - Front and Rear Splash Shields
 - All needed hardware

Part Number: M-2300-BUL



2018-2023 MUSTANG ECOBOOST PERF CALIBRATION

- Fits 2018-2023 Mustang EcoBoost with manual or automatic transmissions (Not for use with 2020-23 2.3 HO)
- Horsepower and torque gains throughout the powerband
- 35 HP peak gain at 2,900 RPM
- 76 Lb.Ft. Torque peak gain at 2,600 RPM

Part Number: M-9603-M4CA





STREET HANDLING PACK

- Fits 2015-2023 Mustang GT and 2.3L EcoBoost Coupes and Convertibles
- Lowers car approximately 1"
- Gives a more aggressive-looking stance with a focus on handling and street performance
- Assembled Front Performance Pack Struts
- Performance Pack Rear Shocks
- Street Lowering Springs M-5300-X
- Performance Pack Upper Strut Mounts M-18183-M
- Jounce Bumper Kit M-5570-B
- Performance Pack Front and Rear Sway Bars
- Performance Pack Rear Toe Links M-5972-M

Part Number: M-FR3A-MAA





2015-2023 MUSTANG TRACK LOWERING SPRING KIT

- Fits 2015 - 2023 Mustang GT and 2.3L EcoBoost Coupes
- Component of the M-FR3A-M8A Handling Pack
- Lowers car approximately 1.0"
- Gives a more aggressive-looking stance with a focus on handling and on track performance
- High quality manufacturing - produced by OEM spring supplier

Part Number: M-5300-YA



2015-2023 MUSTANG STREET LOWERING SPRING KIT

- Fits 2015 - 2023 Mustang GT and 2.3L EcoBoost Coupes
- Designed to work with production struts, shocks and sway bars
- Lowers car approximately 1.0"
- Gives a more aggressive-looking stance, as well as increased handling dynamics while maintaining excellent ride quality
- Highest quality manufacturing - produced by OEM spring supplier

Part Number: M-5300-XA





2015-2023 MUSTANG TRACK HANDLING PACK

- Fits: 2015-2023 Mustang GT and 2.3L EcoBoost Coupes and Convertibles
- All components are designed to work together as a package
- Lowers car approximately 1.0"
- Gives a more aggressive-looking stance with a focus on handling and on track performance

Part Number: M-FR3A-M8A



2015-2024 MUSTANG HALF SHAFT UPGRADE KIT

- Fits in place of production half shafts with no other vehicle modifications
- Severe duty serviceable CV joints with CNC billet centers support up to 1,500 HP
- CNC-machined from aerospace high-alloy materials
- Billet one-piece 34-spline inner and 32-spline outer stub ends
- Axle shafts feature anti-wheel hop technology
- Shafts feature blue powder coating for corrosion resistance
- Built by G-Force Engineering, available only through Ford Performance
- Off-road use only

Part Number: M-4130-MA





CAT BACK EXTREME EXHAUST

- Fits 2018-2023 Mustang GT 5.0L Coupe and Convertible
- Uniquely designed and tuned to provide optimum performance, aggressive sound, durability, and pure driving USA from high quality 304 stainless steel
- Includes X-pipe, 2.5" stainless steel mandrel bent cat-back tubing and clamps for installation
- Sport, Touring, and Extreme sound levels.
- Bolts to stock catalytic converters
- Approximately 30 lbs. lighter than the factory cat-back system
- Uses factory hangers and mounts
- Available with Black, Chrome, or Carbon Tips
- Available for 2.3L and 5.0L

Part Number: M-5200-M8EBA



* Cat Back Extreme Exhaust with Black Tips shown.



FORD PERFORMANCE MUSTANG FRONT FLOOR MAT SET

- Fits 2015-2024 Mustang
- Premium-grade black carpeting is custom fit to the exact contour of Mustang
- “Ford Performance” logo patch is sewn to the floor mat for long lasting durability
- Mat Retention on Driver Side only

Part Number: M-13086-M



2015-2024 MUSTANG FORD PERFORMANCE SILL PLATE SET

- Fits all 2015-2024 Mustang, GT350 and GT350R
- Original equipment on Mustang GT350
- Sill plates proudly display the “Ford Performance” logo
- Set includes both the right and left door sill plate
- Durable black ABS construction
- Easy Installation

Part Number: M-1613208-A





MUSTANG CARBON FIBER SHIFT KNOB

- Fits stock 2015-2042 Mustang shifter, M-7210-M8 and M-7210-MA Ford Performance Short Throw Shifters
- 6-speed carbon fiber shift knob with genuine carbon fiber weave
- Retains stock M12 x 1.25 thread for shift knob

Part Number: M-7213-MCF

MUSTANG BULLITT™ WHITE SHIFT KNOB

- Fits stock 2015-2024 Mustang shifter, M-7210-M8 and M-7210-MA Ford Performance Short Throw Shifter
- Classic white 6-speed shift knob as used on the Mustang Bullitt™
- Retains stock M12 x 1.25 thread for shift knob

Part Number: M-7213-M8B

FORD PERFORMANCE SHIFT KNOB 6-SPEED

- Fits stock 2015-2024 Mustang shifter, M-7210-M8 and M-7210-MA Ford Performance Short Throw Shifters
- 6-speed black shift knob with "Ford Performance" logo
- Retains stock M12 x 1.25 thread for shift knob

Part Number: M-7213-M8A





**FORD PERFORMANCE
PARTS**

RANGER ACCESSORIES



[PERFORMANCEPARTS.FORD.COM](https://www.performanceparts.ford.com)

SEPTEMBER 2023

**SUBURBAN
ACCESSORIES**



DYNO GRAY WHEEL KIT

- Fits 2019 -2023 Ranger 4WD Models
- Premium OEM aluminum wheels with matte Dyno Gray finish and clear coated to OEM standards
- Includes Four Ranger TPMS Sensors and Activation Tool
- Includes "FORD" Raptor/Ranger style Center Cap Kit M-1096K-RA
- 17" x 8.5" wide
- 6-lug, 139.7 mm bolt circle
- 55 mm offset
- 177.5 mm backspacing

Part Number: M-1007K-RGR1785OR



BLACK MACHINED FACE WHEEL KIT

- Fits 2019-2023 Ranger
- Gloss black paint finish, with machined face
- Set of 4 Wheels - 18" x 8"
- Black Chrome Ford oval center caps
- TPMS sensor and activation tool kit

Part Number: M-1007K-DC18X8BMF





BLACK LUG NUTS

- Fits M12 x 1.5 wheel stud
- Vehicle kit contains 24 lug nuts
- Black chrome finish

Part Number: M-1012K-BR





BLACK OVAL KIT

- Fits all 2019-2023 Ranger
- Original equipment on 2021-2023 Ranger Black Appearance Package
- Front smoked chrome oval
- Rear smoked chrome oval

Part Number: M-1447-RNGR



"FORD" GRILL

- Fits all 2019-2023 Ranger
- Direct bolt-on replacement

Part Number: M-8200-FRD





FORD PERFORMANCE PARTS BY RIGID® RANGER 40" OFF-ROAD LIGHT BAR KIT

- Perfect for Overlanding.
- This kit contains RIGID® Radiance Plus 40" light bar, unique harness, switch, and lens covers.

Part Number: M-15200K-R



FORD PERFORMANCE PARTS BY RIGID® RANGER HOOD HINGE-MOUNTED OFF ROAD LIGHT KIT

- The kit allows you to mount RIGID's D-SS-Series LED lights onto the Ranger's hood hinges, giving you two LED off-road lights at the base of the A-Pillars.
- The kit includes two RIGID D-SS-Series lights, two black powder coated stainless steel brackets, a unique harness with toggle switch, and "Ford Performance" branded lens covers.
- Ideal for Overlanding.

Part Number: M-15200-RHM





2019-2023 RANGER TREMOR GRILLE AND FORD OVAL PACKAGE

- Fits 2019-2023 Ranger
- Grille finished in Magnetic Gray with Red nostril accents, complete with replacement Smoked Ford Ovals
- Kit Includes:
 - Tremor Series Grille
 - Front & Rear Smoked Ford Oval
 - Direct bolt-on replacement

Part Number: M-8200-TMR



FORD PERFORMANCE RANGER WINDSHIELD BANNER

- Fits: 2019-2022 Ranger
- Die-cut lettering that will adhere to a properly prepared windshield
- Designed specifically to follow the natural curvature of the factory windshield
- Banner has white "FORD" and red "PERFORMANCE" lettering

Part Number: M-1820-RGR





2019-2023 RANGER WHEEL LIP MOLDING KIT

- Fits all 2019-2023 Ranger
- 1" wider for added clearance & appearance
- Kit includes:
 - Set of 4 Wheel Lip Moldings with Magnetic Gray Finish

Part Number: M-19008-RT

RANGER OFF-ROAD HOOP STEPS

- Fits 2019-2023 Ranger Crew Cab
- Original Equipment on the Ranger Tremor
- Bolt-on Installation. Hardware included.
- Sold as a pair

Part Number: M-16450-RTS

M12X1.5 BLACK SECURITY LUG NUT KIT OF 4

- Fits M14 x 1.5 wheel stud
- Black chrome finish
- Kit contains 5 security lug nuts and key

Part Number: M-1A043-B





POWER PACK

- Ford Performance engineered and dyno tested
- Improved drivability and throttle response throughout RPM range
- Optimized shift schedule
- Horsepower gain: 45 HP @ 4,500 RPM
- Torque gain: 60 lb.-ft. @ 2,500 RPM
- Tire size configurable up to a maximum diameter equivalent to a 265/70R17 tire as recommended with the M-18000-R Ranger Off-Road Suspension Leveling Kit
- Premium fuel - 91 octane or higher is required
- Includes Ford Performance Pro Cal 4 calibration delivery tool M-12655-F
- Includes Ford Performance high-flow K&N® air filter
- Optimized for trailer towing

Part Number: M-9603-REB

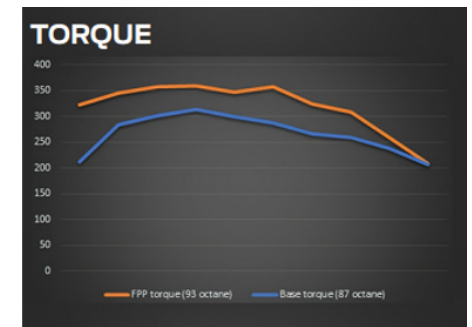
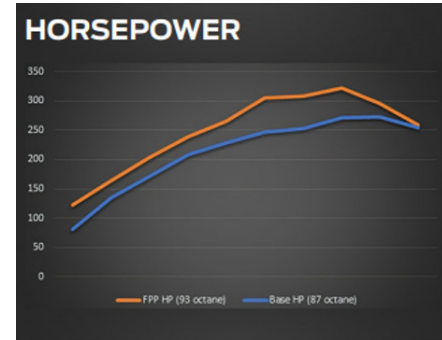



SPORT EXHAUST SYSTEM

- Fits 2019-2023 Ranger 2.3L Super Crew and Super Cab Models
- Ford Performance Ranger Sport exhaust systems are uniquely designed and tuned to provide an aggressive and throaty high-performance sound that is sure to enhance your driving experience
- Dual side exit with black-chrome plated 4-inch stainless steel exhaust tips
- System includes dual-exit Muffler, dual tailpipe assembly with welded-on tips and all clamps needed for installation
- Available in Black or Chrome Tips

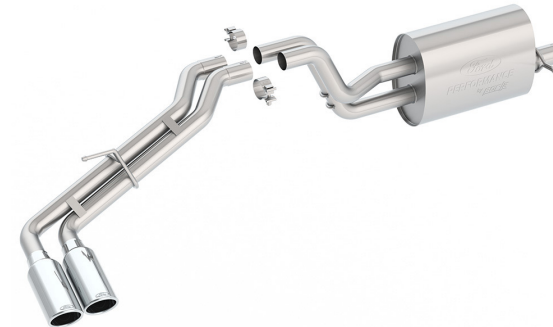

* Sport Exhaust System with Chrome Tips shown.

Part Number: M-5200-RA23SB

OVERLAND SUSPENSION KIT

- Improved comfort, handling, and overall ride quality
- Increases ride height for additional ground clearance
- Intended for handling additional loads for Overlanding
- Validated by Ford Performance Parts Engineers
- Kit Includes:
 - Shocks
 - Struts
 - Coil springs
 - Leaf springs
 - Hardware



Part Number: M-18000-RO



2019-2023 RANGER FOX "TUNED BY FORD PERFORMANCE" OFF-ROAD SUSPENSION LEVELING KIT

- Fits 2019-2023 Ranger 4WD (North American models only)
- Does not fit 2021-2023 Ranger Tremor Package
- Shocks feature precision impact extruded aluminum bodies that increase cooling capacity and are rust resistant
- Front coil-overs feature top quality racing coils selected to deliver the optimal spring rate
- Levels truck front-to-rear
- Improves front approach angle: 34.8 deg. vs. 28.7 deg. stock
- Improves breakover angle: 23.8 deg. vs. 21.5 deg stock
- Vehicle-specific upper front mounts include a composite bushing that isolates noise and vibration
- Provides a comfortable on-road ride and predictable off-road handling in even the toughest conditions
- Easy bolt-on installation with no other modifications required

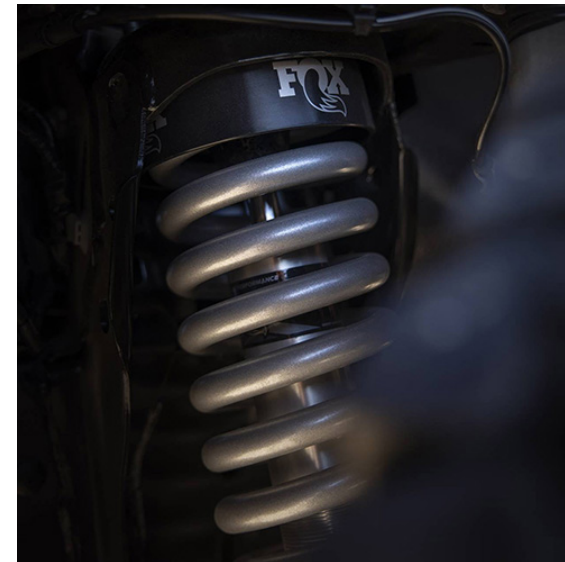

Part Number: M-18000-RA



**FORD PERFORMANCE
PARTS**

EXPLORER ACCESSORIES



[PERFORMANCEPARTS.FORD.COM](https://www.performanceparts.ford.com)

SEPTEMBER 2023

**SUBURBAN
ACCESSORIES**



TIMBERLINE OFF-ROAD LIGHT

- The dark Carbonized Gray grille has provisions already incorporated along with a wiring harness for dealer-installed Ford Performance auxiliary lights with an output of 160,000 candelas to illuminate nighttime trails. This equates to 2.5 times the brightness of the Explorer Timberline high-beam headlamps
- This kit enables easy installation of 2 - 10" LED Off-Road lights that can be integrated into the grille of a 2021-2023 Explorer Timberline.
- The kit comes with unique harness and bracket and can be operated from the Auxiliary switch on the headlight switch
- This kit only fits 2021-2023 Explorer Timberline

Part Number: M-15200K-EGL



BLACK LUG NUTS

- Fits M14 x 1.5 wheel stud
- Kit contains 20 Lug Nuts
- Matte black finish

Part Number: M-1012K-MB





ST PERFORMANCE CALIBRATION

- Improved throttle response throughout RPM range
- Optimized transmission shift schedule
- 25-35 lb.-ft. torque gains* from 2,000-4,000 RPM
- Peak torque = 467 lb.-ft. at 3,500 RPM
- 30 HP gain at 5,000 RPM
- Peak power = 430 HP at 6,000 RPM
- M-12655-F ProCal 4 delivery tool included
- * Premium fuel required*

Part Number: M-9603-EX30

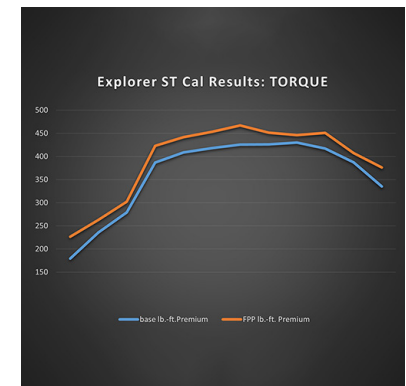
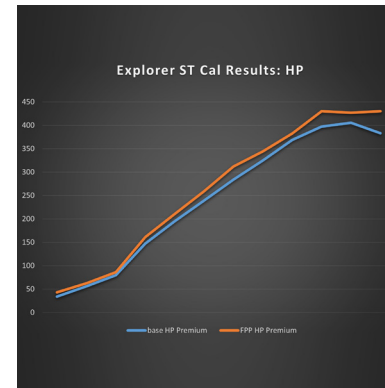



**FORD PERFORMANCE
PARTS**

MAVERICK ACCESSORIES



[PERFORMANCEPARTS.FORD.COM](https://www.performanceparts.ford.com)

SEPTEMBER 2023

**SUBURBAN
ACCESSORIES**



M14 X 1.5 BLACK LUG NUT VEHICLE KIT OF 20

- Black finish
- Fits M14 x 1.5 wheel stud
- Kit contains 20 Lug Nuts

Part Number: M-1012K-MB

RIGID® OFF-ROAD UNDER BODY/ ROCK LIGHT KIT-WHITE

- Perfect for overlanding
- This kit contains 4 RIGID® LED Rock Lights (white light) plus 15-foot leads to each light, power distribution block, switch, and light mounts
- RIGID® Rock Lights contain a high quality black aluminum housing with a durable polycarbonate lens.

Part Number: M-15200-RUN

2022+ MAVERICK CHASE RACK

- Fits all series 2022+ Maverick
- Features Maverick Logo on side panels
- Retains the factory High-Mount Stop Light
- Made with 2" tubular steel
- Bolt-on installation

Part Number: M-19007-MV

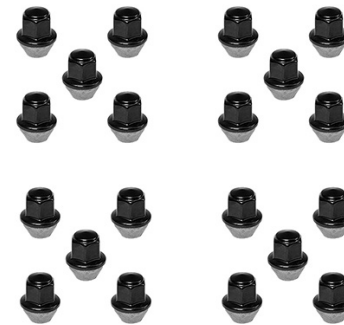



**FORD PERFORMANCE
PARTS**

CRATE ENGINES

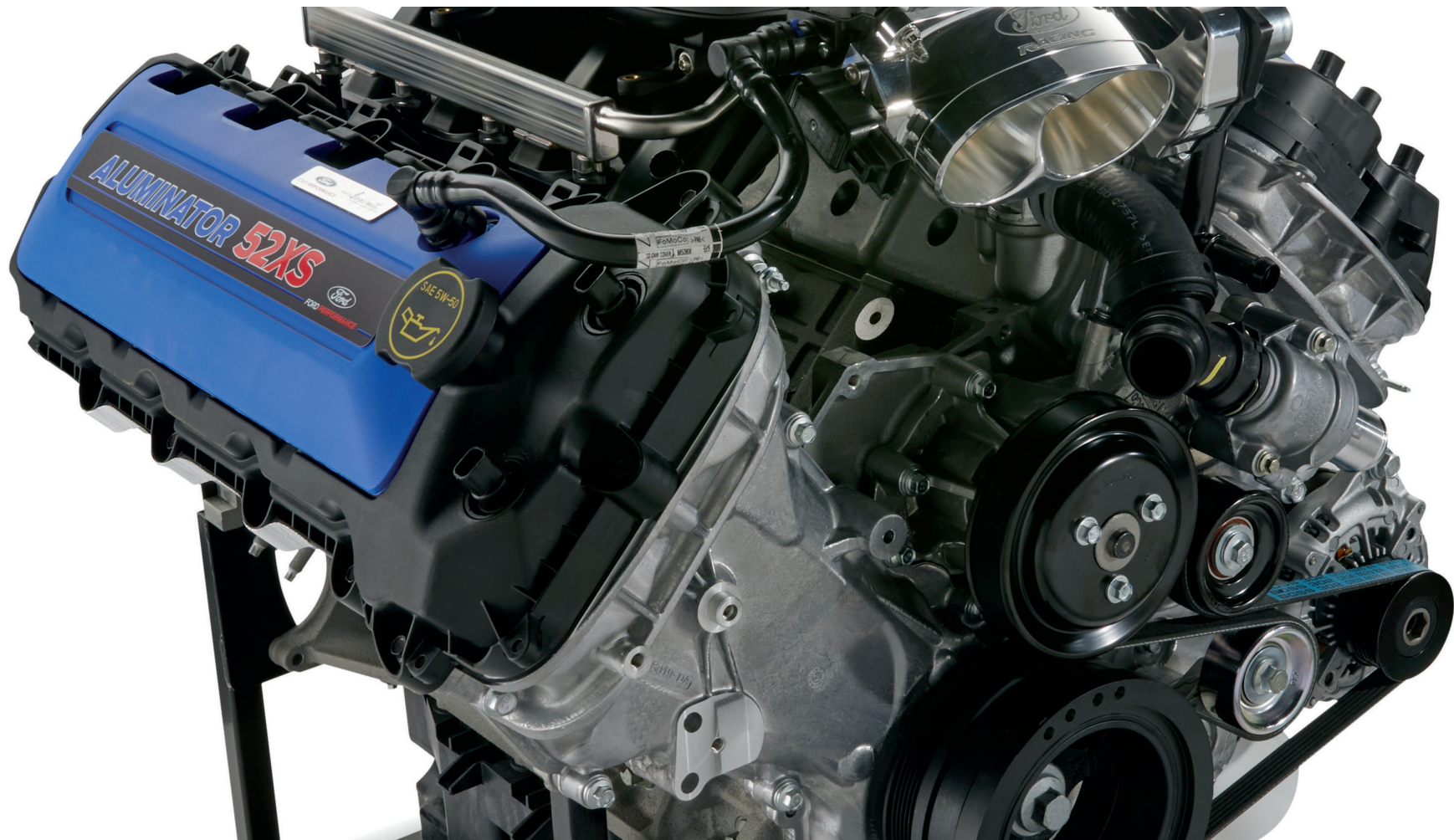

[PERFORMANCEPARTS.FORD.COM](https://www.performanceparts.ford.com)

SEPTEMBER 2023

**SUBURBAN
ACCESSORIES**



5.2L ALUMINATOR 5.2 XS CRATE ENGINE

- Designed to work with 2015-2017 Mustang GT electronics-custom calibration required!
- 580 Horsepower @ 7,800 RPM
- 445 lb.-ft. Torque @ 4,500 RPM
- 5.2L
- 317 Cubic Inches
- 12:1 Compression Ratio

Part Number: M-6007-A52XS



5.0L GEN 3 ALUMINATOR NA CRATE ENGINE

- Fits 2018-2021 Mustang GT
- 5.0L (302 cubic inches)
- 12:1 compression ratio
- 460 horsepower @ 7,000 rpm
- 420 ft.-lb. torque at 4,600 rpm

Part Number: M-6007-A50NAB





5.0L GEN 3 ALUMINATOR SC CRATE ENGINE

- Fits 2018-2021 Mustang GT
- 5.0L (302 cubic inches)
- 9.5:1 compression ratio for supercharged applications

Part Number: M-6007-A50SCB



GEN 3 5.0L COYOTE 460HP MUSTANG CRATE ENGINE

- 460 Horsepower @ 7,000 rpm
- 420 ft.-lb.+ of Torque @ 4,600 rpm
- 12.0:1 Compression ratio

Part Number: M-6007-M50C





GEN 3 5.0L NMRA COYOTE STOCK SEALED ENGINE

- 'Sealed' Gen 3, 2020 Coyote crate engine for use by NMRA-Coyote stock racing competitors ONLY
- 460 horsepower @ 7,000 rpm
- 420 ft.-lb.+ of torque @4,600 rpm
- 12.0:1 Compression ratio
- *Proof of NMRA membership/competition license must be provided to frpp@ford.com.

Part Number: M-6007-M50SB



302 CI 340 HP BOSS CRATE ENGINE WITH "E" CAM

- 340 HP
- 9.0:1 compression ratio
- Can be used in kit cars, street rods, Mustangs, Fox-bodied cars, and trucks
- (Rear sump pan fits most Fox body cars)

Part Number: M-6007-X2302E





X2347D STREET CRUISER-DRESSED CRATE ENGINE WITH X2 HEADS- FRONT SUMP PAN

- 360 Horsepower/400 lb.-ft. of Torque
- Engine type: 302 based small block Ford
- Compression ratio: 9.6:1

Part Number: M-6007-X2347DF



X2347D STREET CRUISER-DRESSED CRATE ENGINE WITH X2 HEADS- REAR SUMP PAN

- 360 Horsepower/400 lb.-ft. of Torque
- Engine type: 302 based small block Ford
- Compression ratio: 9.6:1

Part Number: M-6007-X2347DR





**FORD PERFORMANCE
PARTS**

CRATE ENGINE PUSHROD 302

363 CUBIC INCH 507 HP BOSS CRATE ENGINE-Z2 HEADS-FRONT SUMP PAN

- 507 horsepower @ 6,500 rpm
- 450 lb. -ft. torque @ 5,100 rpm
- Compression ratio: 10.2:1

Part Number: M-6007-Z2363FT

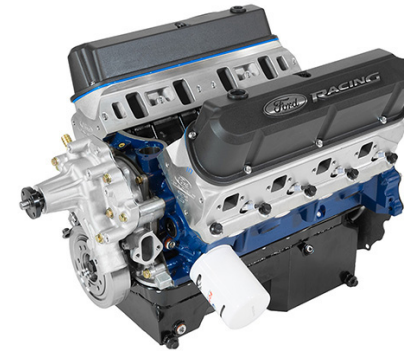

363 CUBIC INCH 507 HP BOSS CRATE ENGINE-Z2 HEADS-REAR SUMP PAN

- 507 horsepower @ 6,500 rpm
- 450 lb. -ft. torque @ 5,100 rpm
- Compression ratio: 10.2:1

Part Number: M-6007-Z2363RT

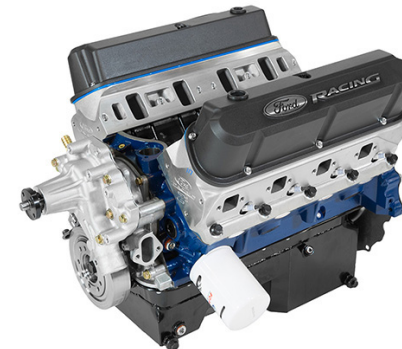



**FORD PERFORMANCE
PARTS**

CRATE ENGINE PUSHROD 351

427 CUBIC INCH 535 HP BOSS CRATE ENGINE-Z2 HEADS-FRONT SUMP PAN

- 535 horsepower @ 5,600 rpm
- 545 lb.-ft. torque @ 4,500 rpm
- Compression ratio: 10.5:1

Part Number: M-6007-Z2427FFT



427 CUBIC INCH 535 HP BOSS CRATE ENGINE-Z2 HEADS-REAR SUMP PAN

- 535 horsepower @ 5,600 rpm
- 545 lb.-ft. torque @ 4,500 rpm
- Compression ratio: 10.5:1

Part Number: M-6007-Z2427FRT





**FORD PERFORMANCE
PARTS**

CRATE ENGINE PUSHROD 351

460 CUBIC INCH 575 HP BOSS CRATE ENGINE-FRONT SUMP PAN

- 575 Horsepower @ 5,500 RPM
- 575 lb.-ft. Torque @ 4,700 RPM
- Compression ratio: 10.0:1

Part Number: M-6007-Z460FFT



460 CUBIC INCH 575 HP BOSS CRATE ENGINE-REAR SUMP PAN

- 575 Horsepower @ 5,500 RPM
- 575 lb.-ft. Torque @ 4,700 RPM
- Compression ratio: 10.0:1

Part Number: M-6007-Z460FRT





347 CUBIC INCH 415 HP SEALED RACING ENGINE

- 415 hp @ 6,000 rpm
- 400 lb-ft @ 4,900 rpm (with headers, and a 650 CFM Holley carburetor not included)
- 10:1 Compression ratio
- Limited supplies of sealed racing engines are manufactured to support specific racing series. For ordering information, please contact the Ford Performance Techline.

Part Number: M-6007-D347SR

**CIRCLE TRACK
D347SR**



347 CUBIC INCHES 415 HP SEALED RACING ENGINE 7MM VALVES

- 7mm lightweight intake and exhaust valves
- 415 hp @ 6,000 rpm
- 400 lb-ft @ 4,900 rpm (with headers, and a 650 CFM Holley carburetor not included)
- 10:1 Compression ratio
- Limited supplies of sealed racing engines are manufactured to support specific racing series. For ordering information, please contact the Ford Performance Techline.

Part Number: M-6007-D347SR7

**CIRCLE TRACK
D347SR**





**FORD PERFORMANCE
PARTS**

CRATE ENGINE PUSHROD - RACE

347CI 350HP CRATE ENGINE-SEALED RACING X2 CYLINDER HEAD

- Built for asphalt and circle track racing series that require a sealed or "crate" racing engine
- 350 hp @ 5500 rpm
- 400 lb-ft of torque @ 4000 rpm (with headers, and 2V 500 CFM Holley carburetor not included)
- 10.5:1 Compression ratio
- Limited supplies of sealed racing engines are manufactured to support specific racing series. For ordering information, please contact the Ford Performance Techline.

Part Number: M-6007-S347JR2

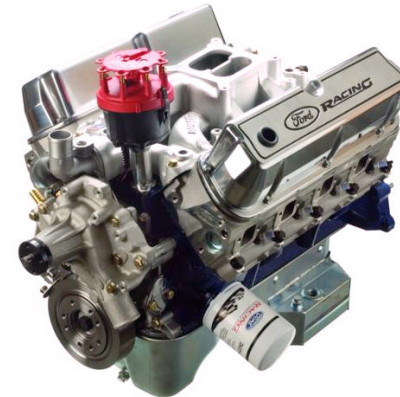



**FORD PERFORMANCE
PARTS**

CRATE ENGINE ECOBOOST

2.3L 310HP MUSTANG ECOBOOST ENGINE KIT

- 2.3L EcoBoost engine as used in the 2018 Mustang
- 310HP/350 lb.-ft. Torque @ 3,000 rpm (with 93 octane fuel)
- Designed for traditional rear drive installations

Part Number: M-6007-23TA





**FORD PERFORMANCE
PARTS**

CRATE ENGINE PUSHROD 7.3L

7.3L V8 430HP SUPER DUTY CRATE ENGINE

- The 7.3L V8 Ford gasoline crate engine for the 2020 F250 Super Duty features:
- 7.3L displacement
- 430 HP at 5,500 rpm
- 475 lb/ft of torque at 4,000 rpm
- 10.5:1 compression

Part Number: M-6007-73





572 CUBIC INCH 655 HP BIG BLOCK STREET CRATE ENGINE-FRONT SUMP PAN

- 655 Horsepower @ 5500 rpm
- 710 lb.-ft. torque @ 4500 rpm
- Compression ratio: 10.0:1

Part Number: M-6007-572DF

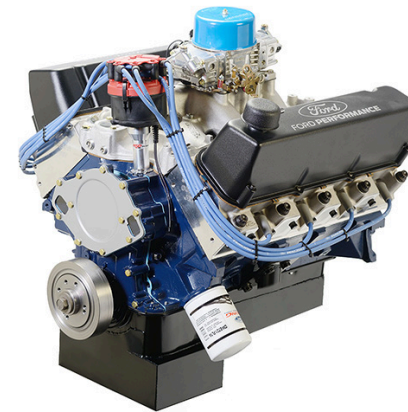

572 CUBIC INCH 655 HP BIG BLOCK STREET CRATE ENGINE-REAR SUMP PAN

- 655 Horsepower @ 5500 rpm
- 710 lb.-ft. torque @ 4500 rpm
- Compression ratio: 10.0:1

Part Number: M-6007-572DR

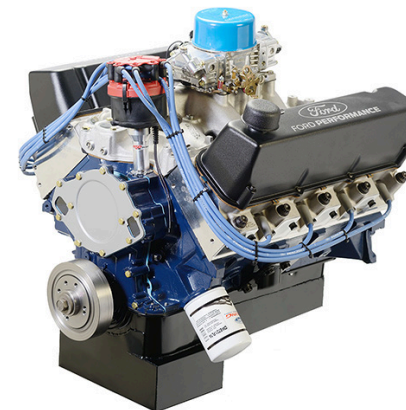



BRONCO APPEARANCE	
METHOD WHEEL KIT	M-1007K-M1785ME
EVERGLADES WHEEL KIT	M-1007K-P1785E
BLACK LUG NUTS	M-1012K-BR
WHEEL & TIRE KIT	M-1007K-BR1785
ORANGE BEAD LOCK TRIM RING KIT	M-1021K-BLO
RED BEAD LOCK TRIM RING KIT	M-1021K-BLR
BLACK BEAD LOCK TRIM RING KIT	M-1021K-BLB
TUBE DOOR KIT 2-DOOR	M-19008-BTD2
TUBE DOOR KIT 4-DOOR	M-19008-BTD4
HOOP STEPS	M-16450-BH4
RIGID ROOF MOUNTED & POD LIGHTS	M-15200K-BML
RIGID 40" OFF ROAD LIGHT BAR	M-15200K-BRRL
WINCH KIT	M-1821-B
WINCH RECEIVER KIT	M-1821-WR
TOW HOOKS RED	M-1821-UHR
2021+ BRONCO BLACKOUT KIT -SASQUATCH	M-1019-BBK
2021+ BRONCO BEAD LOCK CAPABLE WHEEL KIT -WILDTRAK	M-1007K-DC1785A
2021-2023 BRONCO 17"X8" BEAD LOCK CAPABLE WHEEL KIT -BADLANDS	M-1007K-DC178B
2021-2023 BRONCO 18" BLACK MACHINED FACE WHEEL KIT	M-1007K-BB5
2021-2023 BRONCO 17" X 8.5" WHEEL KIT - DYN0 GRAY	M-1007K-BR1785
BRONCO/BRONCO SPORT G.O.A.T. BADGE - BLACK/BLACK	M-1447-GOATBLK
BRONCO REAR EMBLEM - GLOSS BLACK	M-1447-BRB
2021+ BRONCO GRILLE LETTERING OVERLAY KIT - BLACK	M-1447-BLMB
TOW HOOKS BLUE	M-821-UHB



BRONCO DUAL MOUNTED MIRROR OFF-ROAD LIGHTS	M-15200K-BDML
BRONCO UNDERHOOD AIR COMPRESSOR KIT	M-1830-BRC
2021-2023 BRONCO HOOD LIFT KIT	M-16826-B
RIGID® OFF-ROAD UNDER BODY/ROCK LIGHT KIT-WHITE	M-15200-RUN
RIGID® OFF-ROAD UNDER BODY/ROCK LIGHT KIT-AMBER	M-15200-RUNA
M14X1.5 BLACK SECURITY LUG NUT KIT OF 5	M-1A043-A5
M12X1.5 BLACK SECURITY LUG NUT KIT OF 5	M-1A043-B5
BRONCO INTERIOR	
2021+ BRONCO FORD PERFORMANCE SILL PLATE KIT	M-1613208-B
2021-2023 BRONCO CARBON FIBER GRAB HANDLE KIT	M-7220-BCF
BRONCO PERFORMANCE	
BRONCO PRO CALIBRATION KIT 2.3L	M-9603-B23
BRONCO PRO CALIBRATIONS KIT 2.7L	M-9603-B27
BRONCO SUSPENSION	
OFF-ROAD SUSPENSION 2" LIFT KIT 2 DOOR	M-18000-B1A
OFF-ROAD SUSPENSION 2" LIFT KIT 4 DOOR	M-18000-B1
BRONCO EXHAUST	
CAT BACK EXHAUST 2.3L BLACK TIP-PLATED STAINLESS STEEL	M-5230-BR3SB
CAT BACK EXHAUST 2.7L BLACK TIP-PLATED STAINLESS STEEL	M-5230-BR7SB
CAT BACK EXHAUST 2.3L CHROME TIP-PLATED STAINLESS STEEL	M-5230-BR3SC
CAT BACK EXHAUST 2.7L CHROME TIP-PLATED STAINLESS STEEL	M-5230-BR7SC
2021-2023 BRONCO 2.3L HIGH CLEARANCE EXHAUST SYSTEM	M-5230-BR3
2021-2023 BRONCO 2.7L HIGH CLEARANCE EXHAUST SYSTEM	M-5230-BR7



F-150 APPEARANCE	
OFF-ROAD BLACK PACKAGE	M-F150-OR20
FORD PERFORMANCE TONNEAU COVER 5.5FT BED	M-98150-FP
20" WHEEL & TIRE PACKAGE (MOUNTED/BALANCED)	M-1007K-S2085F15B
22" WHEEL & TIRE PACKAGE (MOUNTED/BALANCED)	M-1007K-S2295GB
BLACK LUG NUTS	M-1012K-F15B
BLACK WITH MACHINED FACE	M-1007K-S2295B
SINISTER BRONZE	M-1007K-S2295SB
2021-2023 F-150 BLACK OVAL KIT	M-1447-FBC1/M-1447-F15B
2015-2023 F-150 TOW HOOKS-PAIR-RED	M-18954-F15R
2015-2023 F-150 TOW HOOKS-PAIR-BLUE	M-18954-F15B
FORD PERFORMANCE F-SERIES WINDSHIELD BANNER	M-1820-WR
9.75" F-150 RAPTOR DIFFERENTIAL COVER	M-4033-F975
2015-2023 F-SERIES OFF-ROAD RUNNING BOARD	M-16450-FSORB
2015-2023 F-150/RAPTOR CHASE RACK	M-19007-F15R
2021+ F-150 FRONT SKID PLATE KIT	M-5018-FSP
2021+ F-150 18" MATTE BLACK WHEEL KIT	M-1007K-1875MB
M14X1.5 BLACK SECURITY LUG NUT KIT OF 4	M-1A043-A
F-150 PERFORMANCE	
3.0L WHIPPLE SUPERCHARGER KIT	M-6066-F150SCA
3.0L WHIPPLE SUPERCHARGER KIT WITH PRO POWER ON BOARD	M-6066-F150SCB
OFF-ROAD SUSPENSION 2" LEVELING KIT	M-18000-F15B
EXHAUST REAR EXIT	M-5200-FEBR
EXHAUST SIDE EXIT	M-5200-FEBS



F-150 SUSPENSION	
2021+ F-150 REAR LOWERING KIT	M-3000-HB
F-150 EXHAUST	
EXHAUST REAR EXIT	M-5200-FEBR
EXHAUST SIDE EXIT	M-5200-FEBS
F-150 INTERIOR	
2015-2022 FORD PERFORMANCE PREMIUM F-150 FRONT FLOOR MAT SET	M-13086-FA
2015-2023 F-150 FORD PERFORMANCE SILL PLATE SET	M-1613208-F15A



SUPER DUTY APPEARANCE	
WINCH KIT	M-1821-SD
WINCH KIT RECEIVER	M-1821-WR
TOW HOOK BLUE	M-1821-UHB
TOW HOOK RED	M-1821-UHR
MATTE BLACK WHEEL KIT	M-1007K-1808SD
OFF-ROAD RUNNING BOARDS	M-16450-FSORB
BLACK OVAL KIT WITHOUT CAMERA PROVISION	M-1447-SDC
BLACK OVAL KIT WITH CAMERA	M01447-SDB
2005-2023 SUPER DUTY 20" CALIBER WHEEL KIT -GLOSS BLACK	M-1007K-S2008GB1
2005-2023 SUPER DUTY 20" X 8" PREMIUM BLACK PAINTED ALUMINUM WHEEL	M-1007K-SU2008EB
2017-2023 SUPER DUTY TOW HOOKS-PAIR-RED	M-18954-SDR
2017-2023 SUPER DUTY TOW HOOKS-PAIR-BLUE	M-18954-SDB
2017-2023 FORD PERFORMANCE SUPER DUTY CHASE RACK	M-19007-SD
RIGID OFF-ROAD UNDER BODY LIGHT KIT	M-15200-RUN
SUPER DUTY EXHAUST	
7.3L SPORT EXHAUST	M-5200-FSD73SB
2017-2023 SUPER DUTY EXHAUST TIP - BLACK CHROME	M-5260-BCT3
2017-2023 SUPER DUTY EXHAUST TIP - CHROME	M-5260-CT3
SUPER DUTY PERFORMANCE	
FORD PERFORMANCE LOW PROFILE INTAKE FOR 7.3L GAS ENGINE	M-9424-73LP



MUSTANG APPEARANCE	
HP PERFORMANCE PACK WHEEL KIT	M-1007K-DC19XMB
BLACK LUG NUTS	M-1012K-MB
2020-2022 GT500 CARBON FIBER HOOD VENT	M-16612-C20
2020-2022 GT500 CARBON FIBER FRONT SPLITTER	M-16601-MCF
2020-2022 GT500 CARBON FIBER BUMPER INSERT	M-17750-MCF
2020-2022 GT500 CARBON FIBER REAR DECKLID TRIM PANEL	M-16600-MCF
2015-2024 MUSTANG 5.0L FENDER EMBLEMS/BADGES-BLACK-PAIR	M-1447-M50AB
2015-2024 MUSTANG 5.0L FENDER EMBLEMS/BADGES-CHROME-PAIR	M-1447-M50A
2018-2023 FORD PERFORMANCE MUSTANG CLEAR TAILLAMP KIT	M-13504-MC
FORD PERFORMANCE WHEEL CENTER CAP	M-1096-FP3
2015-23 MUSTANG REAR SPOILER WITH GURNEY FLAP	M-16600-FP
2005-2023 MUSTANG FORD PERFORMANCE WINDSHIELD BANNER-WHITE AND RED	M-1820-MR
2015-2023 MUSTANG HOOD LIFT KIT W/ ENGRAVED FORD PERFORMANCE LOGO	M-16826-MA
M14X1.5 BLACK SECURITY LUG NUT KIT OF 4	M-1A043-A
MUSTANG PERFORMANCE	
ROUSH SUPERCHARGER KIT	M-6066-M8MY22
2015-2023 MUSTANG BULLITT™ BRAKE KIT	M-2300-BUL
2018-2023 MUSTANG ECOBOOST PERF CALIBRATION	M-9603-M4CA
MUSTANG SUSPENSION	
STREET HANDLING PACK	M-FR3A-MAA
2015-2023 MUSTANG TRACK LOWERING SPRING KIT	M-5300-YA
2015-2023 MUSTANG STREET LOWERING SPRING KIT	M-5300-XA
2015-2023 MUSTANG TRACK HANDLING PACK	M-FR3A-M8A
2015-2024 MUSTANG HALF SHAFT UPGRADE KIT	M-4130-MA



**FORD PERFORMANCE
PARTS**

MUSTANG PART NUMBERS

MUSTANG EXHAUST	
CAT BACK EXTREME EXHAUST	M-5200-M8EBA
MUSTANG INTERIOR	
FORD PERFORMANCE MUSTANG FRONT FLOOR MAT SET	M-13086-M
2015-2024 MUSTANG FORD PERFORMANCE SILL PLATE SET	M-1613208-A
MUSTANG CARBON FIBER SHIFT KNOB	M-7213-MCF
MUSTANG BULLITT™ WHITE SHIFT KNOB	M-7213-M8B
FORD PERFORMANCE SHIFT KNOB 6-SPEED	M-7213-M8A



RANGER APPEARANCE	
DYNO GRAY WHEEL KIT	M-1007K-RGR1785OR
BLACK MACHINED FACE WHEEL KIT	M-1007K-DC18X8BMF
BLACK LUG NUTS	M-1012K-BR
BLACK OVAL KIT	M-1447-RNGR
"FORD" GRILL	M-8200-FRD
2019-2023 RANGER TREMOR GRILLE AND FORD OVAL PACKAGE	M-8200-TMR
FORD PERFORMANCE RANGER WINDSHIELD BANNER - WHT/RED	M-1820-RGR
FORD PERFORMANCE PARTS BY RIGID® RANGER 40" OFF-ROAD LIGHT BAR KIT	M-15200K-R
RIGID® RANGER HOOD HINGE-MOUNTED OFF ROAD LIGHT KIT	M-15200-RHM
RANGER OFF-ROAD HOOP STEPS	M-16450-RTS
2019-2023 RANGER WHEEL LIP MOLDING KIT	M-19008-RT
M12X1.5 BLACK SECURITY LUG NUT KIT OF 4	M-1A043-B
RANGER PERFORMANCE	
POWER PACK	M-9603-REB
SPORT EXHAUST SYSTEM	M-5200-RA23SB
OVERLAND SUSPENSION KIT	M-18000-RO
RANGER SUSPENSION	
2019-2023 RANGER FOX OFF-ROAD SUSPENSION LEVELING KIT	M-18000-RA



**FORD PERFORMANCE
PARTS**

EXPLORER PART NUMBERS

EXPLORER APPEARANCE	
TIMBERLINE OFF-ROAD LIGHT	M-15200K-EGL
BLACK LUG NUTS	M-1012K-MB
EXPLORER PERFORMANCE	
ST PERFORMANCE CALIBRATION	M-9603-EX30



BRONCO SPORT APPEARANCE	
RIGID® OFF-ROAD UNDER BODY/ROCK LIGHT KIT-WHITE	M-15200-RUN
RIGID® OFF-ROAD UNDER BODY/ROCK LIGHT KIT-AMBER	M-15200-RUNA
PARTS BY RIGID® BRONCO SPORT ROOF OFF-ROAD LIGHT BAR KIT	M-15200K-CXR
2021-2023 BRONCO SPORT 17" X 7" WHEEL KIT -GLOSS BLACK	M-1007K-BS17GB
2021+ BRONCO SPORT 17" WHEEL KIT -LOW GLOSS BLACK	M-1007K-S17BSB
M12 X 1.5 BLACK LUG NUT VEHICLE KIT OF 20	M-1012K-BSB
M12X1.5 BLACK SECURITY LUG NUT KIT OF 4	M-1A043-B
BRONCO/BRONCO SPORT G.O.A.T. BADGE - BLACK/CHROME	M-1447-GOAT
BRONCO/BRONCO SPORT G.O.A.T. BADGE - BLACK/CHROME	M-1447-GOATBLK
BRONCO SPORT EXHAUST	
2021-2023 BRONCO SPORT 2.0L SPORT EXHAUST - BLACK	M-5230-BSB
2021-2023 BRONCO SPORT 2.0L SPORT EXHAUST - CHROME	M-5230-BSC



**FORD PERFORMANCE
PARTS**

MAVERICK PART NUMBERS

MAVERICK APPEARANCE	
M14 X 1.5 BLACK LUG NUT VEHICLE KIT OF 20	M-1012K-MB
RIGID® OFF-ROAD UNDER BODY/ROCK LIGHT KIT-WHITE	M-15200-RUN
2022+ MAVERICK CHASE RACK	M-19007-MV



CRATE ENGINES	
7.3L V8 430HP SUPER DUTY CRATE ENGINE	M-6007-73
5.2L ALUMINATOR 5.2 XS CRATE ENGINE	M-6007-A52XS
5.0L GEN 3 ALUMINATOR NA CRATE ENGINE	M-6007-A50NAB
5.0L GEN 3 ALUMINATOR SC CRATE ENGINE	M-6007-A50SCB
GEN 3 5.0L COYOTE 460HP MUSTANG CRATE ENGINE	M-6007-M50C
GEN 3 5.0L NMRA COYOTE STOCK SEALED ENGINE	M-6007-M50SB
302 CI 340 HP BOSS CRATE ENGINE WITH "E" CAM	M-6007-X2302E
X2347D STREET CRUISER-DRESSED CRATE ENGINE WITH X2 HEADS-FRONT SUMP PAN	M-6007-X2347DF
X2347D STREET CRUISER-DRESSED CRATE ENGINE WITH X2 HEADS-REAR SUMP PAN	M-6007-X2347DR
363 CUBIC INCH 507 HP BOSS CRATE ENGINE-Z2 HEADS-FRONT SUMP PAN	M-6007-Z2363FT
363 CUBIC INCH 507 HP BOSS CRATE ENGINE-Z2 HEADS-REAR SUMP PAN	M-6007-Z2363RT
427 CUBIC INCH 535 HP BOSS CRATE ENGINE-Z2 HEADS-FRONT SUMP PAN	M-6007-Z2427FFT
427 CUBIC INCH 535 HP BOSS CRATE ENGINE-Z2 HEADS-REAR SUMP PAN	M-6007-Z2427FRT
460 CUBIC INCH 575 HP BOSS CRATE ENGINE-FRONT SUMP PAN	M-6007-Z460FFT
460 CUBIC INCH 575 HP BOSS CRATE ENGINE-REAR SUMP PAN	M-6007-Z460FRT
347 CUBIC INCH 415 HP SEALED RACING ENGINE	M-6007-D347SR
347 CUBIC INCHES 415 HP SEALED RACING ENGINE 7MM VALVES	M-6007-D347SR7
347CI 350HP CRATE ENGINE-SEALED RACING X2 CYLINDER HEAD	M-6007-S347JR2
2.3L 310HP MUSTANG ECOBOOST ENGINE KIT	M-6007-23TA
572 CUBIC INCH 655 HP BIG BLOCK STREET CRATE ENGINE-FRONT SUMP PAN	M-6007-572DF
572 CUBIC INCH 655 HP BIG BLOCK STREET CRATE ENGINE-REAR SUMP PAN	M-6007-572DR